



LIERRE TOTEM

Did you know that ivy symbolises fidelity and eternal life? With this in mind, our designers came up with a piece of furniture perfectly suited to parks and gardens. The slender, sturdy base rises up towards its setting. Lierre is flexible yet solid, airy yet light. Designed for green spaces, it can also find a place of choice in urban environments.

Technical specifications :

Formats: A1 | A2 | A3

Height: 140cm

Materials: Powder-coated steel in a choice of RAL colours

Decors : Lava enamelled, ClearSign®, etc.

Anchoring: On a concrete base using a base plate

Graphic design and installation optional.

Installation on FERRADIX® optional

Other types in the range :

Lectern, Double Lectern.









Please note that specifications are subject to change.

Textured colour :

-  Mars 2525
-  Black 100 sanded
-  Grey 900 sanded

Smooth colour :

-  RAL 8007
Fawn Brown
-  RAL 5014
Blue grey
-  RAL 6009
Pine green
-  RAL 5011
Steel blue
-  RAL 9005
Black
-  RAL 3005
Red Wine
-  RAL 7016
Anthracite

Dimensions (in mm) :

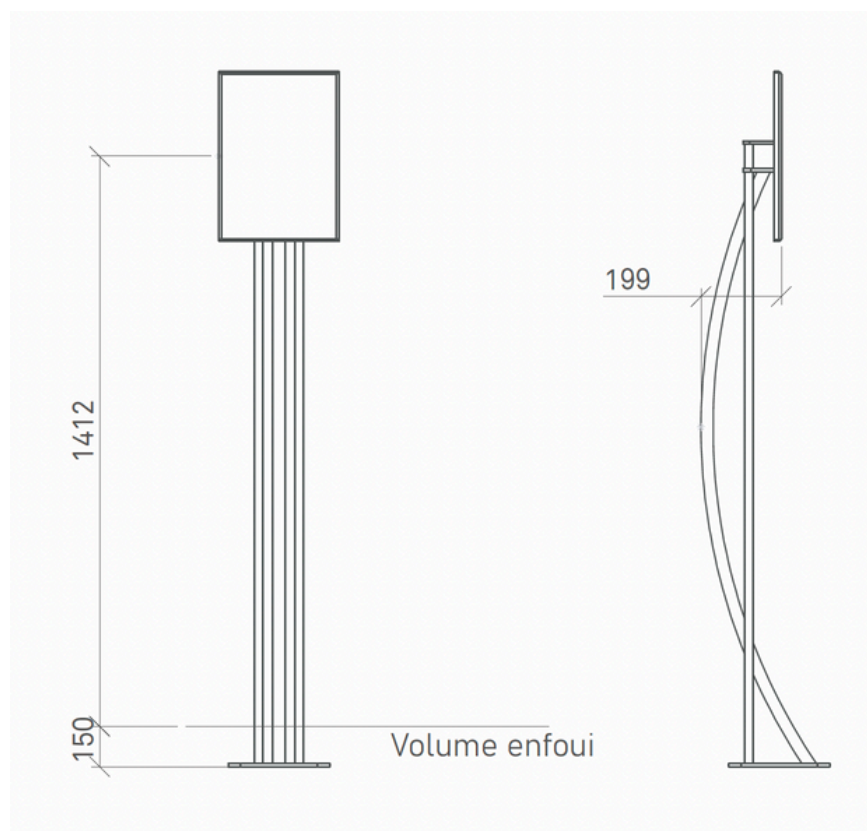



LAVA ENAMELED

Recognized know-how for your signage

Enameled lava corresponds to a technique created by Parisian artists in the 19th century. This involves covering a lava stone with a vitrified layer. This typically French know-how is today recognized as an art profession.

Enameled lava can receive all types of illustrations and texts, which retain their vibrant colours over the years, thanks to the properties of the material itself. Very resistant, it is an ideal product for exterior signage. Enameled lava is suitable for the "panel" part. It cannot be used to create a furniture structure.

Imprint, Company of Living Heritage

This label, awarded by the Ministry of the Economy after a series of audits, rewards companies holding rare, valuable know-how and promoting the excellence of French manufacturing throughout the world. It attests to our sensitivity to the issues of conservation and enhancement of heritage.



Main Features :



Ease of maintenance



Natural product



100% recyclable



Longevity 10-year guarantee



French product



Scratch and impact resistant



Easy graffiti removal



Total resistance to bad weather



Protected know-how



Pollution resistance

Technical specifications:

Dimensions and shapes:

Thickness 15 mm Maximum dimensions: 500 x 1000 mm (min 50 x 50 mm), Weight per m²: 22 kg

Thickness 25 mm Maximum dimensions: 1000 x 2000 mm (min 100 x 100 mm) Weight per m²: 55 kg

Types of finishing:

The unprinted surface may be glossy or satin.

Maintenance tips :

Enameled lava signage is very easy to maintain:

Ordinary dirt: cleaning with water, ordinary high-pressure cleaner permitted

Graffiti: cleaning with an ordinary anti-tag product, followed by rinsing with clean water.



Clear Sign®

The solution for your signage

Registered trademark, the Clearsign technique includes its main qualities in its name:

- C** - Clarity
- L** - Lightfastness
- E** - Environment (Eco friendly)
- A** - Abrasion Resistant
- R** - Recyclable

In signage, these advantages are major. The technique is however simple. A powder-coated aluminum plate is printed and powder-coated again. The print is thus encapsulated between two very hard layers. The result is stunning, the colors vibrant, the resistance incomparable, both to shocks, scratches and graffiti.

The decorations are printed in high resolution on a wide range of powder-coated colours. The varnish is necessarily shiny. Not available in matte finish.

Technical specifications:

Finishes:

Gloss - Graffiti resistant coating

Artwork Supply :

Full size, CMYK, 300 dpi jpegs, 5mm bleed, no crop marks

Impression :

Colour printing on white surface
Colour printing on coloured surface
White printing on coloured surface

Maintenance:

Recommended cleaning products*:

Ethanol
Turpentine
Xylene

**Stronger solvents (MEK, Acetone, Nitrocellulose solvent, etc.) should be used with caution and will be the customer's responsibility.*

Please note that specifications are subject to change.



Advantage :



Not flammable



High resolution printing



Easy graffiti removal



Colour Clarity



Visual quality
guaranteed for 7
years (excluding
vandalism)



THE RECOMMENDATIONS

Maintaining your signage

To maintain your signage (all surfaces except wood), we recommend that you completely dust the surfaces approximately once a month using a dry cloth.

Secondly, clean the plates with a soft cloth soaked in household alcohol. This measure will optimize the readability and shine of your plates.

For enameled lava, occasional use of a high-pressure cleaner (apart from the joints) can help lighten the cracking and remove stains and graffiti.

For cleaning specific stains or for any other questions, contact us.

